

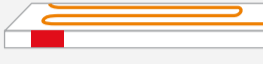









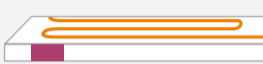



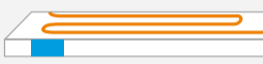

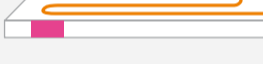

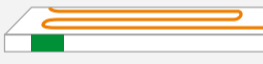
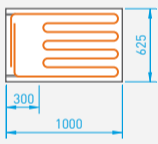



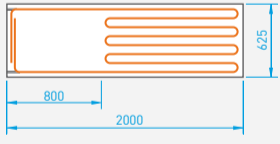

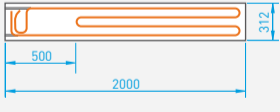
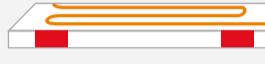

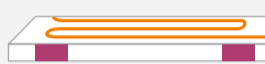
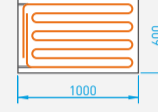
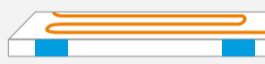
Information leaflet for ModularPanels

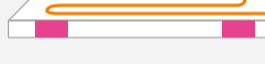
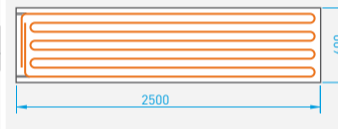
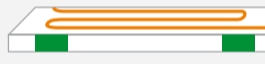
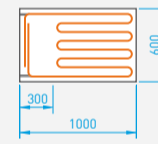

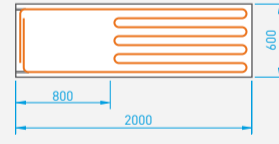

ModularPanels-Classic			Width of panels 625 / 312 mm		
Part No.	Colour code	Dimensions [mm]	Panel area	Heating/ Cooling area	Weight
V020-100			1.25 m ²	1.25 m ²	25.5 kg
V020-102			0.63 m ²	0.63 m ²	12.8 kg
V020-104			0.62 m ²	0.62 m ²	12.6 kg
V020-105			0.94 m ²	0.94 m ²	19.2 kg
V020-107			1.56 m ²	1.56 m ²	31.8 kg
V020-120			0.63 m ²	0.48 m ²	13.0 kg
V020-124			1.25 m ²	1.04 m ²	25.8 kg
V020-128			1.25 m ²	0.79 m ²	26.2 kg
V020-130			0.62 m ²	0.47 m ²	12.8 kg



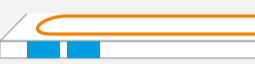
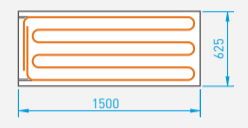
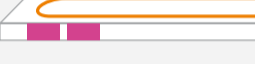
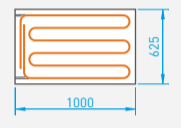

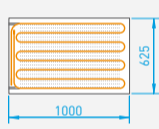
ModularPanels-Classic			Width of panels 600 mm		
Part No.	Colour code	Dimensions [mm]	Panel area	Heating/ Cooling area	Weight
V020-101			1.20 m ²	1.20 m ²	24.5 kg
V020-103			0.60 m ²	0.60 m ²	12.2 kg
V020-106			0.90 m ²	0.90 m ²	19.2 kg
V020-108			1.50 m ²	1.50 m ²	31.8 kg
V020-121			0.60 m ²	0.46 m ²	12.5 kg
V020-125			1.20 m ²	1.00 m ²	24.8 kg
V020-129			1.20 m ²	0.76 m ²	25.1 kg

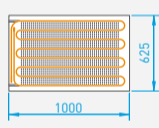

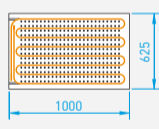

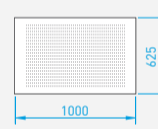

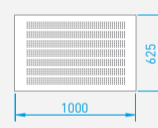
Information leaflet for ModularPanels

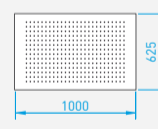
ModularPanels-Classic for ModularCeiling (pipe spacing 105 mm)			Plattenbreite 625 mm		
Part No.	Colour code	Dimensions [mm]	Panel area	Heating/Cooling area	Weight
V020-140			1.25 m ²	1.25 m ²	25.6 kg
V020-141			0.94 m ²	0.94 m ²	19.2 kg
V020-142			0.63 m ²	0.63 m ²	12.9 kg

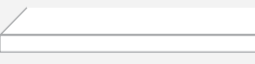
ModularPanels-Acoustic				Width of panels 625 mm		
Part No.	Hole size	Dimensions [mm]	Hole diameter	Panel area	Heating/Cooling area	Weight
V024-109			6 mm	0.63 m ²	0.63 m ²	11.6 kg
V024-104			8 mm	0.63 m ²	0.63 m ²	10.5 kg
V024-110			12 mm	0.63 m ²	0.63 m ²	11.4 kg

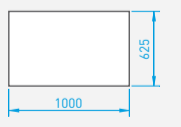
ModularBlankPanels-Acoustic				Width of panels 625 mm		
Part No.	Colour code	Dimensions [mm]	Hole diameter	Panel area	Heating/Cooling area	Weight
V021-113			6 mm	0.63 m ²	--	12.7 kg
V021-108			8 mm	0.63 m ²	--	11.6 kg
V021-114			12 mm	0.63 m ²	--	12.5 kg

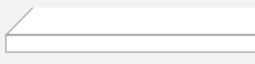
ModularBlankPanels-Classic			Width of panels 625 mm		
Part No.	Colour code	Dimensions [mm]	Panel area	Heating/Cooling area	Weight
V021-100			1.25 m ²	--	27.1 kg
V021-102			0.63 m ²	--	13.6 kg

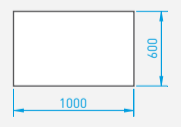
ModularBlankPanels-Classic			Width of panels 600 mm		
Part No.	Colour code	Dimensions [mm]	Panel area	Heating/Cooling area	Weight
V021-101			1.20 m ²	--	26.0 kg
V021-103			0.60 m ²	--	13.0 kg

Turn the page

