

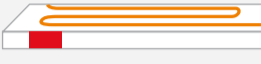









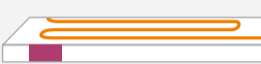
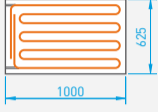
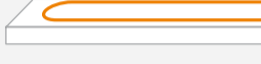

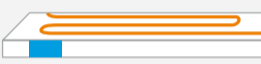

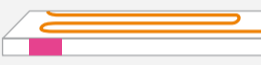

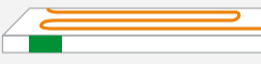
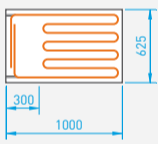
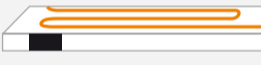

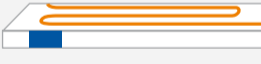
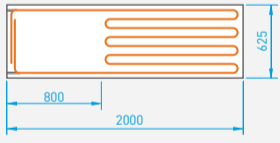

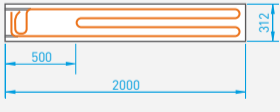
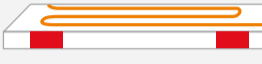

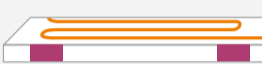

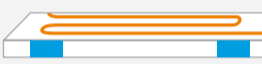

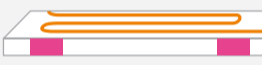

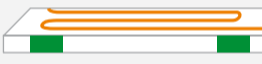
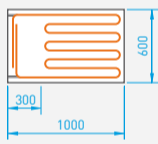
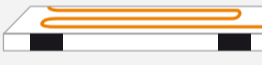

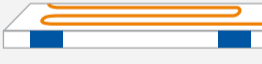
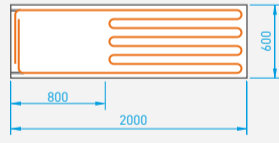
Informationsblatt für ModulPlatten

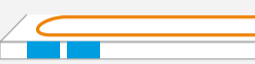
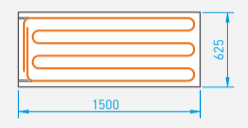
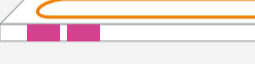
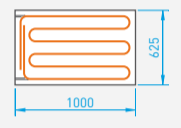

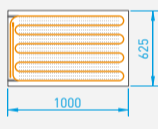

ModulPlatten-Classic			Plattenbreite 625 / 312 mm		
Art.-Nr.	Farbcode	Abmessungen [mm]	Plattenfläche	Heiz-/Kühlfläche	Gewicht
V020-100			1,25 m ²	1,25 m ²	25,5 kg
V020-102			0,63 m ²	0,63 m ²	12,8 kg
V020-104			0,62 m ²	0,62 m ²	12,6 kg
V020-105			0,94 m ²	0,94 m ²	19,2 kg
V020-107			1,56 m ²	1,56 m ²	31,8 kg
V020-120			0,63 m ²	0,48 m ²	13,0 kg
V020-124			1,25 m ²	1,04 m ²	25,8 kg
V020-128			1,25 m ²	0,79 m ²	26,2 kg
V020-130			0,62 m ²	0,47 m ²	12,8 kg

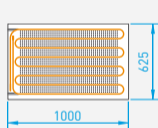

ModulPlatten-Classic			Plattenbreite 600 mm		
Art.-Nr.	Farbcode	Abmessungen [mm]	Plattenfläche	Heiz-/Kühlfläche	Gewicht
V020-101			1,20 m ²	1,20 m ²	24,5 kg
V020-103			0,60 m ²	0,60 m ²	12,2 kg
V020-106			0,90 m ²	0,90 m ²	19,2 kg
V020-108			1,50 m ²	1,50 m ²	31,8 kg
V020-121			0,60 m ²	0,46 m ²	12,5 kg
V020-125			1,20 m ²	1,00 m ²	24,8 kg
V020-129			1,20 m ²	0,76 m ²	25,1 kg

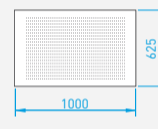

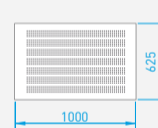
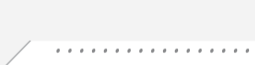
Informationsblatt für ModulPlatten

ModulPlatten-Classic für ModulDecke (Rohrabstand 105 mm)			Plattenbreite 625 mm		
Art.-Nr.	Farbcode	Abmessungen [mm]	Plattenfläche	Heiz-/Kühlfläche	Gewicht
V020-140			1,25 m ²	1,25 m ²	25,6 kg
V020-141			0,94 m ²	0,94 m ²	19,2 kg
V020-142			0,63 m ²	0,63 m ²	12,9 kg

ModulPlatten-Akustik			Plattenbreite 625 mm			
Art.-Nr.	Farbcode	Abmessungen [mm]	Lochdurchmesser	Plattenfläche	Heiz-/Kühlfläche	Gewicht
V024-109			6 mm	0,63 m ²	0,63 m ²	11,6 kg
V024-104			8 mm	0,63 m ²	0,63 m ²	10,5 kg
V024-110			12 mm	0,63 m ²	0,63 m ²	11,4 kg

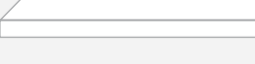
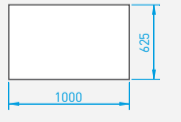
ModulAusbauPlatten-Akustik			Plattenbreite 625 mm			
Art.-Nr.	Farbcode	Abmessungen [mm]	Lochdurchmesser	Plattenfläche	Heiz-/Kühlfläche	Gewicht
V021-113			6 mm	0,63 m ²	--	12,7 kg
V021-108			8 mm	0,63 m ²	--	11,6 kg
V021-114			12 mm	0,63 m ²	--	12,5 kg

ModulAusbauPlatten-Classic			Plattenbreite 625 mm		
Art.-Nr.	Farbcode	Abmessungen [mm]	Plattenfläche	Heiz-/Kühlfläche	Gewicht
V021-100			1,25 m ²	--	27,1 kg
V021-102			0,63 m ²	--	13,6 kg

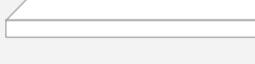
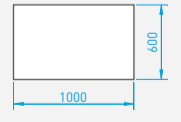
ModulAusbauPlatten-Classic			Plattenbreite 600 mm		
Art.-Nr.	Farbcode	Abmessungen [mm]	Plattenfläche	Heiz-/Kühlfläche	Gewicht
V021-101			1,20 m ²	--	26,0 kg
V021-103			0,60 m ²	--	13,0 kg